

Schnitt 1-1 1:5

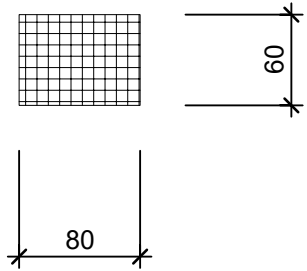

Grundriss 1:5

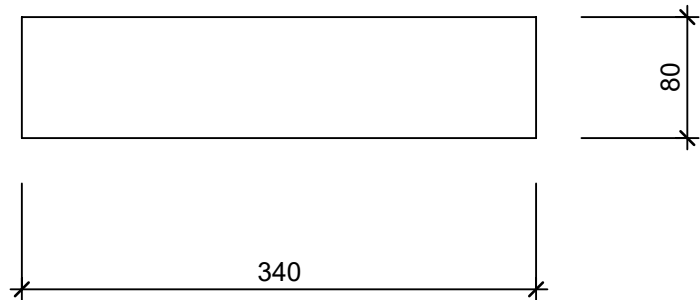

Isometrie 1:5

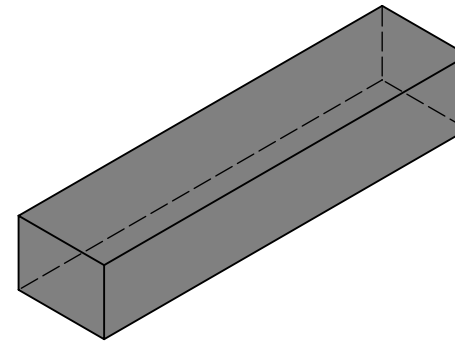

Rubrik: O4001	Art.-Nr: 12135	HW: _2	Massstab: 1:5	Format: DIN A4
Sockel für Pflanzen- und Brunnenträge			Gezeichnet: 22.12.2020 / scj	Geprüft: 12.01.2021 / gch
Sockel			Änderung: /	Geprüft: /
			Änderung:	Geprüft:
			Änderung:	Geprüft:
L 34cm, B 8cm, H 6cm			Ersetzt:	
 CREABETON BAUSTOFF AG 6221 Rickenbach LU info@creabeton-baustoff.ch Telefon 0848 400 401			Plan-Nr: O4001_121352_22_PZ_01_01	